

Precision

Concrete Masonry Units

Introduction.....i

Precision Units

4-Inch Wide.....	1
6-Inch Wide.....	2
Interlocking Fence Units.....	4
Scored Caps & Fence Units	5
8-Inch Wide.....	6
10-Inch Wide	8
12-Inch Wide	9
16-Inch Wide & Pilasters.....	11
45-Degree, Y-Block, & Miter	12
Radius	14
Caps	16
Screen Units.....	17
Sill Block & Combed Face	18

Precision

Description

Precision units are smooth-faced, straight-edged concrete masonry units (CMU). They're the basic, common block type with an as-molded finish produced by vibration during manufacture. Precision units offer the most utility and versatility as seen in the wide range of available units.

Sizes of Precision units are expressed as nominal dimensions that compensate for a standard 3/8-inch mortar joint. That is, an 8x8x16 is actually 7 5/8x7 5/8x15 5/8 inches, with permissible variation in overall dimensions (width, height, length) of $\pm 1/8$ -inch.

Standards

All Precision units manufactured by Angelus Block are hollow or solid loadbearing CMU in accordance with ASTM C90.

Availability

Standard, or stock, items include a variety of widths in three weights:

Normal Weight is stocked in gray and select colors in typical sizes for fence and site walls.

Medium Weight is stocked in gray and a color in a "tan" range.

Lightweight is stocked in gray only and may be limited in availability.

Units shown in this section are generally available except as noted.

Special order items are in addition to normal stock and are indicated as "Special Order Only". Such units require manufacturing lead times and possible minimum quantities. Additional charges may apply depending on order quantities.

Most Precision units may be burnished or shotblast on special order. Please visit www.angelusblock.com for details.

High-Stress units with compressive strengths of 2,500 to 3,750 net psi are available on special order. Limited inventory may be available in some facilities; verify with your representative.

Colors are available on special order from an extensive palette. Contact your representative for color references and materials, or visit Colors & Textures at www.angelusblock.com.

For any special order, whether for configuration, strength, weight, or color, please contact your representative for specific information.

Specifications

Please see Specifications at www.angelusblock.com/specifications.cfm for guide specs containing informative user notes.

Website

Keep current! Visit <https://www.angelusblock.com> for up to date products and information.

©2018 Angelus Block Co., Inc.

The information herein is true and correct to the best of our knowledge but is subject to amendment or correction at any time, without notice. Angelus Block Co., Inc. does not assume responsibility or liability, including liability for negligence, for errors or omissions in this information or in its use in the preparations of architectural or engineering plans or specifications.

4 High

8 High

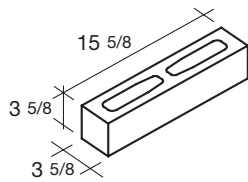

4x4x16
Standard*

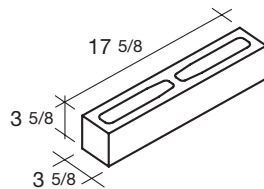

4x4x18
Standard
SPECIAL ORDER ONLY

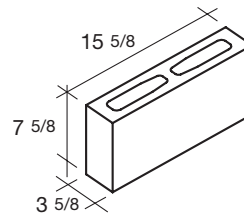

4x8x16
Standard

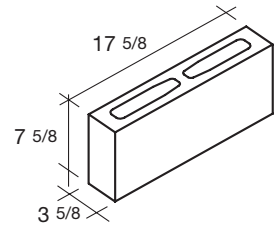

4x8x18
Standard*

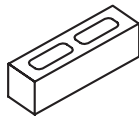

4x4x12
Corner
SPECIAL ORDER ONLY

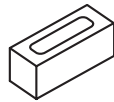

4x4x9
Half
SPECIAL ORDER ONLY

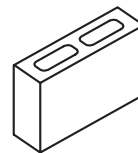

4x8x12
Corner
SPECIAL ORDER ONLY

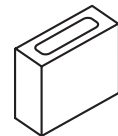

4x8x9
Half
SPECIAL ORDER ONLY

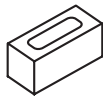

4x4x8
Half
SPECIAL ORDER ONLY

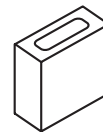

4x8x8
Half*

Pilasters for 4-inch wide units

Use with 4-inch wide units in fence wall applications

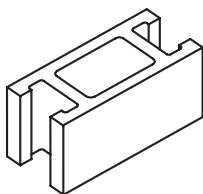

8x8x16
H-Pilaster*

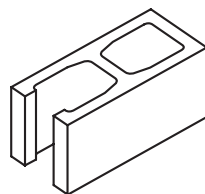

8x8x16
A-Pilaster*

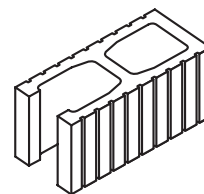

8x8x16
Balboa H-Pilaster
SPECIAL ORDER ONLY

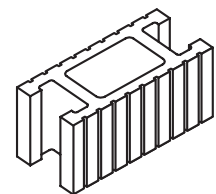

8x8x16
Balboa Open End (Balboa A)
SPECIAL ORDER ONLY

* Limited inventory - verify availability

6 Wide

4 High

6 High

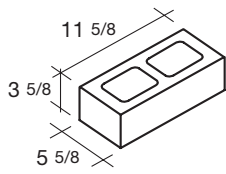

6x4x12
Standard
SPECIAL ORDER ONLY

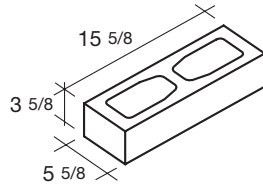

6x4x16
Standard*

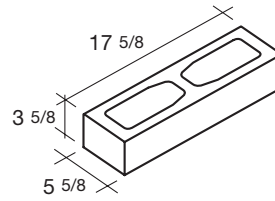

6x4x18
Standard
SPECIAL ORDER ONLY

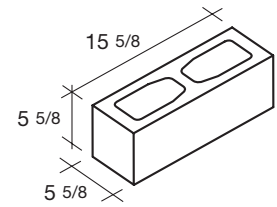

6x6x16
Standard
SPECIAL ORDER ONLY

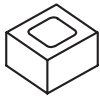

6x4x6
Half
SPECIAL ORDER ONLY

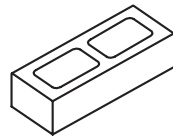

6x4x14
Corner
SPECIAL ORDER ONLY

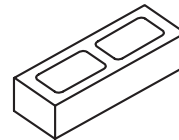

6x4x15
Corner
SPECIAL ORDER ONLY

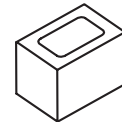

6x6x8
Half
SPECIAL ORDER ONLY

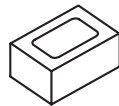

6x4x8
Half
SPECIAL ORDER ONLY

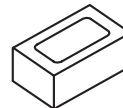

6x4x9
Half
SPECIAL ORDER ONLY

* Limited inventory - verify availability

8 High

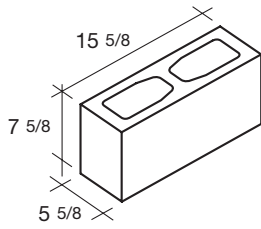

6x8x16
Standard

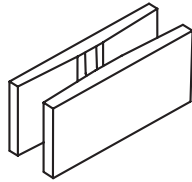

6x8x16
Double Open End Bond Beam*

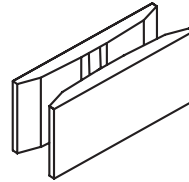

6x8x16
Speed Block
SPECIAL ORDER ONLY

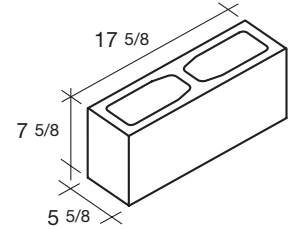

6x8x18
Standard

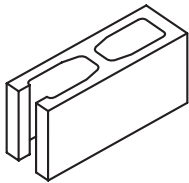

6x8x16
Open End Standard*

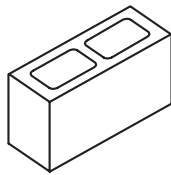

6x8x14
Corner

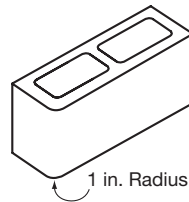

6x8x16
Standard Single Bullnose
SPECIAL ORDER ONLY

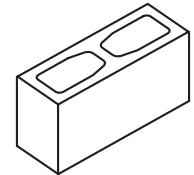

6x8x15
Corner

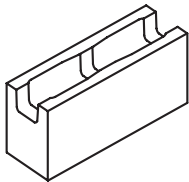

6x8x16
Bond Beam

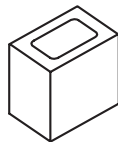

6x8x8
Half

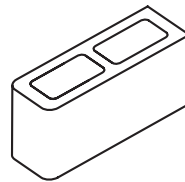

6x8x16
Standard Double Bullnose
SPECIAL ORDER ONLY

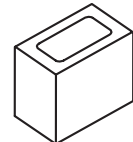

6x8x9
Half

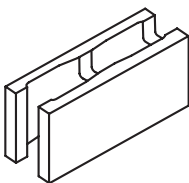

6x8x16
Open End Bond Beam*

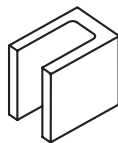

6x8x8
U-Lintel
SPECIAL ORDER ONLY

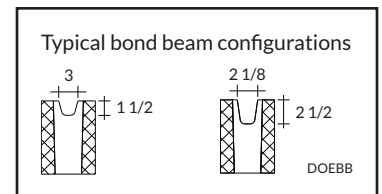

* Limited inventory - verify availability

Note: Open Ends and Bond Beam configurations as shown are representational; available profiles may differ.

Interlocking Fence Units

4 Wide

6 Wide

8 Wide

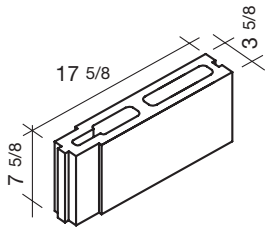

4x8x18
Catalina
SPECIAL ORDER ONLY

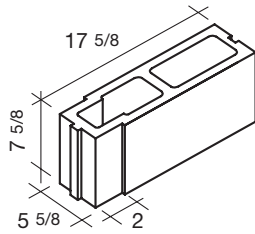

6x8x18
Catalina
SPECIAL ORDER ONLY

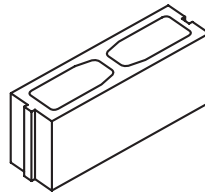

6x8x18
Stucco Block*

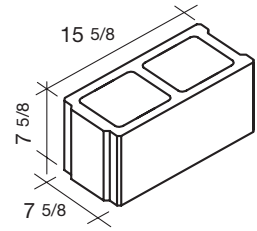

8x8x16
Tongue & Groove Beveled Ends
SPECIAL ORDER ONLY

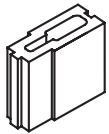

4x8x9
Catalina Half (Breakaway)
SPECIAL ORDER ONLY

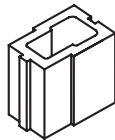

6x8x9
Catalina Half
SPECIAL ORDER ONLY

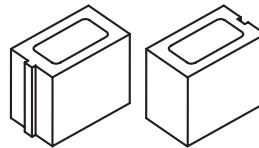

6x8x9
Stucco Block Half (Mixed)
SPECIAL ORDER ONLY

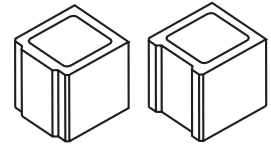

8x8x8
T & G Beveled End Half (Mixed)
SPECIAL ORDER ONLY

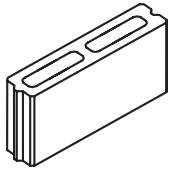

4x8x16
Tongue & Groove Beveled Ends

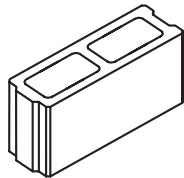

6x8x16
Tongue & Groove Beveled Ends

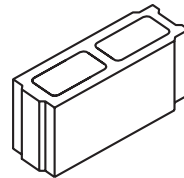

6x8x16
Tongue & Groove with Reveal

This unit is used in Proto II™ Wall System lot separation walls.

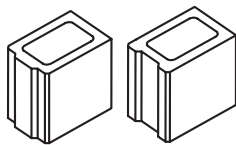

6x8x8
T & G Beveled End Half*
(Mixed)



6x8x8
Tongue & Groove with Reveal Half

* Limited inventory - verify availability

Interlocking Fence Units

4 Wide

6 Wide

8 Wide

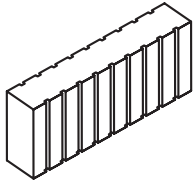

4x8x18
Balboa*

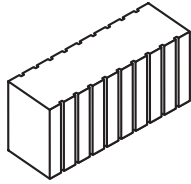

6x8x16
Balboa*

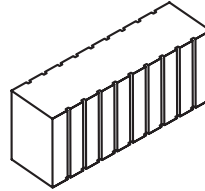

6x8x18
Balboa

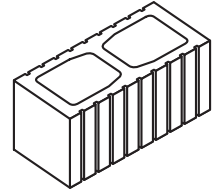

8x8x16
Open Top Balboa
SPECIAL ORDER ONLY

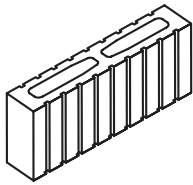

4x8x18
Open Top Balboa
SPECIAL ORDER ONLY

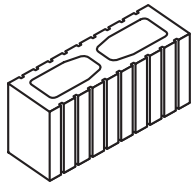

6x8x16
Open Top Balboa
SPECIAL ORDER ONLY

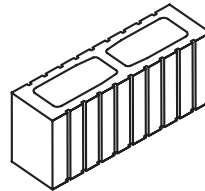

6x8x18
Open Top Balboa
SPECIAL ORDER ONLY

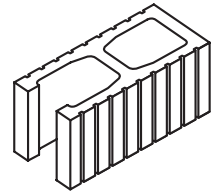

8x8x16
Balboa Open End (Balboa A)
SPECIAL ORDER ONLY

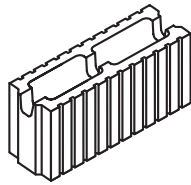

6x8x16
Tongue & Groove 11-Score
Bond Beam Cap*

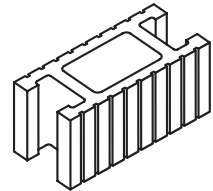

8x8x16
Balboa H-Pilaster
SPECIAL ORDER ONLY

Balboa A and H-Pilaster units are used with 4-inch wide CMU in fence wall applications.

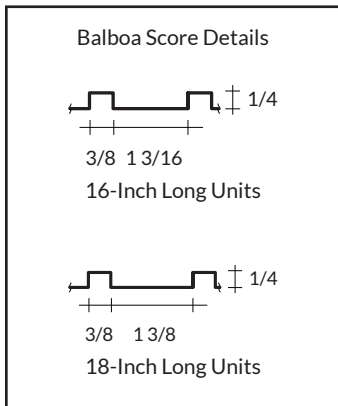

* Limited inventory - verify availability

8 Wide

2 High

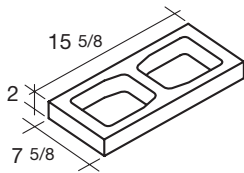

8x2x16
Standard
SPECIAL ORDER ONLY

Actual height is 2 inches.

This unit may have limited location or color availability. Please consult your Angelus Block representative.

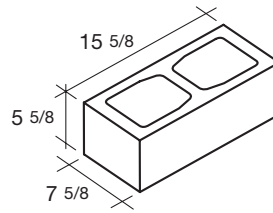

8x6x16
Standard
SPECIAL ORDER ONLY

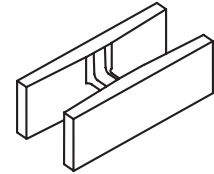

8x6x16
Double Open End Bond Beam
SPECIAL ORDER ONLY

4 High

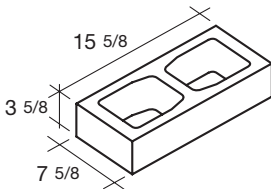

8x4x16
Standard

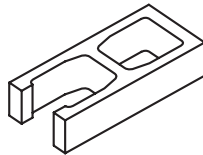

8x4x16
Open End Standard

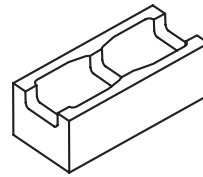

8x6x16
Bond Beam
SPECIAL ORDER ONLY

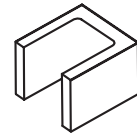

8x6x8
U-Lintel
SPECIAL ORDER ONLY

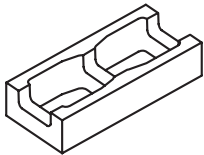

8x4x16
Bond Beam

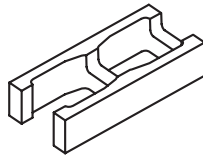

8x4x16
Open End Bond Beam

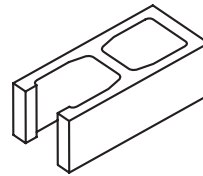

8x6x16
Open End Standard
SPECIAL ORDER ONLY

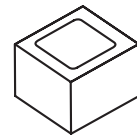

8x6x8
Half
SPECIAL ORDER ONLY

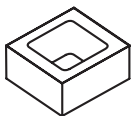

8x4x8
Half

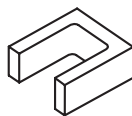

8x4x8
U-Lintel

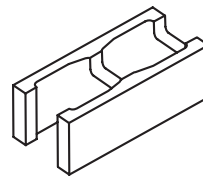

8x6x16
Open End Bond Beam
SPECIAL ORDER ONLY

Note: Open Ends and Bond Beam configurations as shown are representational; available profiles may differ.

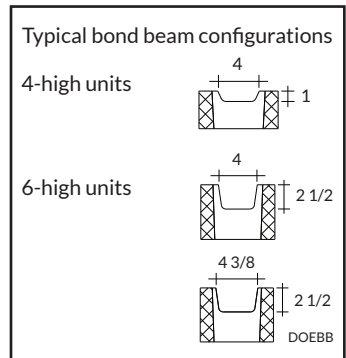

8 High

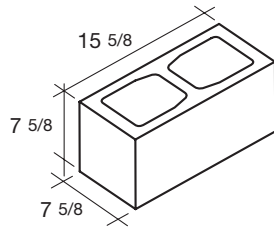

8x8x16
Standard

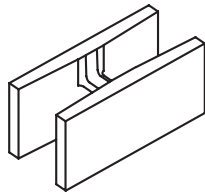

8x8x16
Double Open End Bond Beam

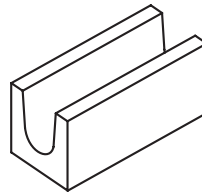

8x8x16
Solid Bottom U-Lintel
SPECIAL ORDER ONLY

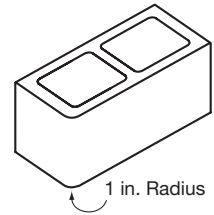

8x8x16
Standard Single Bullnose
SPECIAL ORDER ONLY

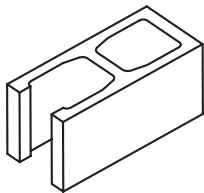

8x8x16
Open End Standard

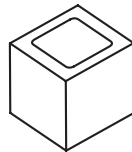

8x8x8
Half

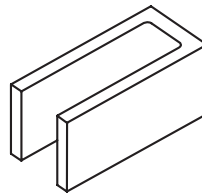

8x8x16
U-Lintel

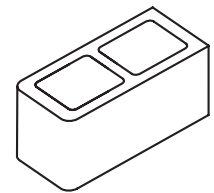

8x8x16
Standard Double Bullnose
SPECIAL ORDER ONLY

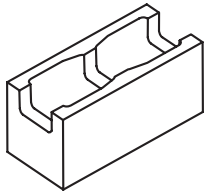

8x8x16
Bond Beam

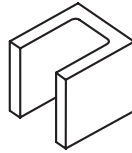

8x8x8
U-Lintel

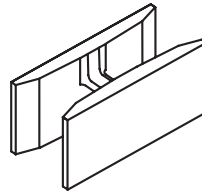

8x8x16
Speed Block*

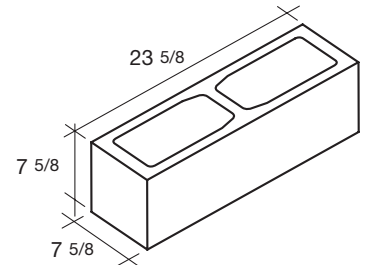

8x8x24
Standard
SPECIAL ORDER ONLY

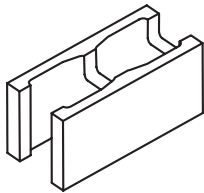

8x8x16
Open End Bond Beam

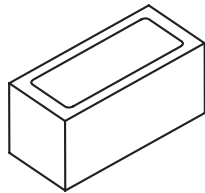

8x8x16
Standard No Center Web

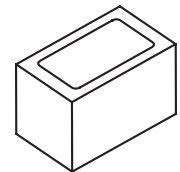

8x8x12
Half
SPECIAL ORDER ONLY

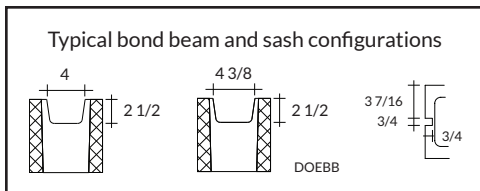

* Limited inventory - verify availability

Note: Open Ends and Bond Beam configurations as shown are representational; available profiles may differ.

10 Wide

4 High

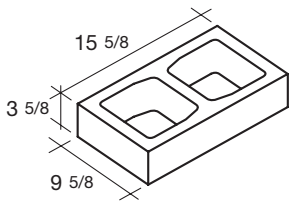

10x4x16
Standard
SPECIAL ORDER ONLY

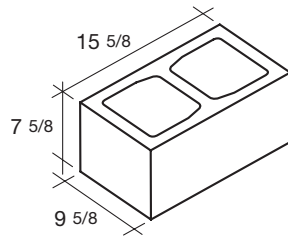

10x8x16
Standard*

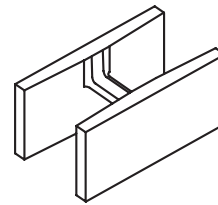

10x8x16
Double Open End Bond Beam
SPECIAL ORDER ONLY

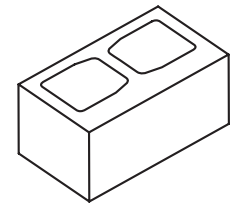

10x8x16
w/ 8-Inch Offset Core
SPECIAL ORDER ONLY

Offset Core units may be available in additional configurations.

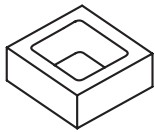

10x4x8
Half
SPECIAL ORDER ONLY

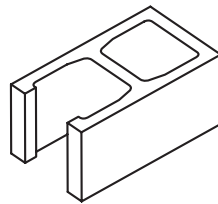

10x8x16
Open End Standard*

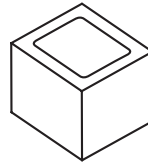

10x8x8
Half*

6 High

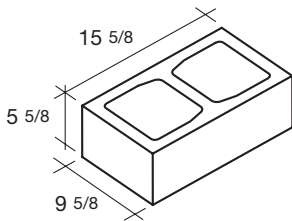

10x6x16
Standard
SPECIAL ORDER ONLY

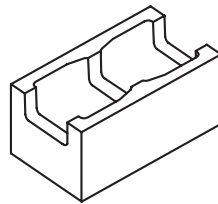

10x8x16
Bond Beam*

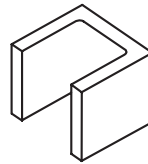

10x8x8
U-Lintel*

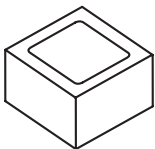

10x6x8
Half
SPECIAL ORDER ONLY

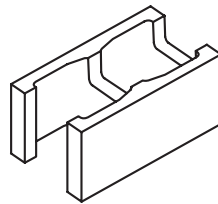

10x8x16
Open End Bond Beam*

Typical bond beam configurations

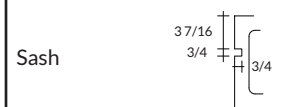
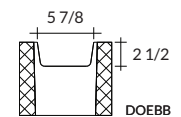
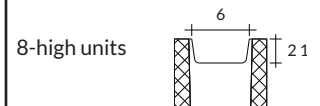
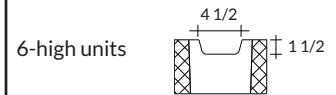
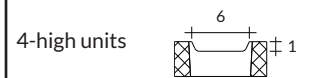

* Limited inventory - verify availability

Note: Open Ends and Bond Beam configurations as shown are representational; available profiles may differ.

4 High

6 High

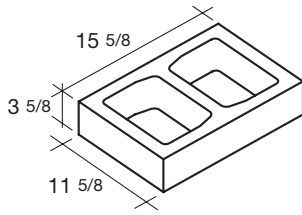

12x4x16
Standard

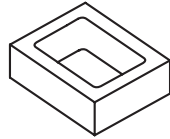

12x4x8
Half

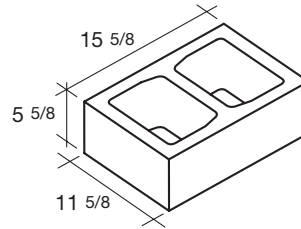

12x6x16
Standard
SPECIAL ORDER ONLY

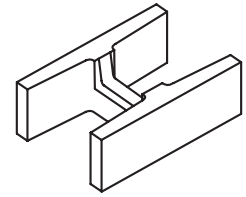

12x6x16
Double Open End Bond Beam
SPECIAL ORDER ONLY

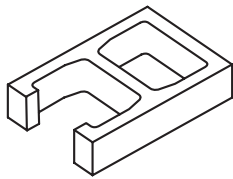

12x4x16
Open End Standard

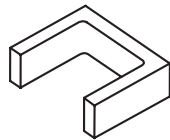

12x4x8
U-Lintel

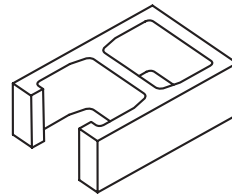

12x6x16
Open End Standard
SPECIAL ORDER ONLY

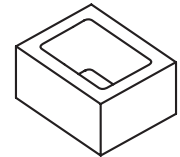

12x6x8
Half
SPECIAL ORDER ONLY

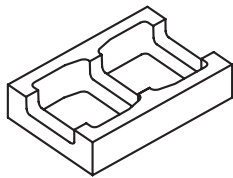

12x4x16
Bond Beam

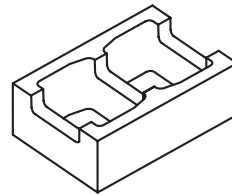

12x6x16
Bond Beam
SPECIAL ORDER ONLY

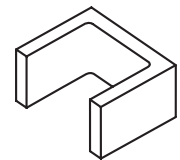

12x6x8
U-Lintel
SPECIAL ORDER ONLY

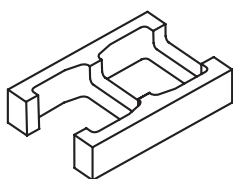

12x4x16
Open End Bond Beam

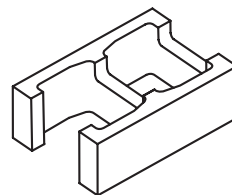

12x6x16
Open End Bond Beam
SPECIAL ORDER ONLY

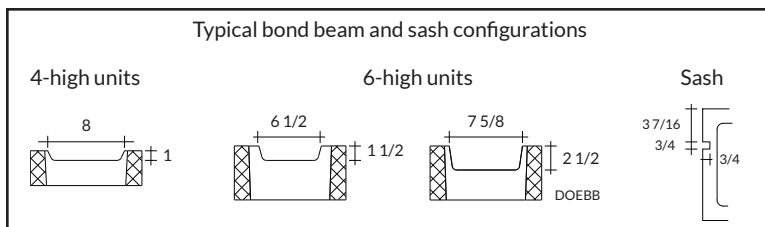

Note: Open Ends and Bond Beam configurations as shown are representational; available profiles may differ.

12 Wide

8 High

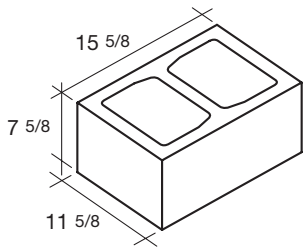

12x8x16
Standard

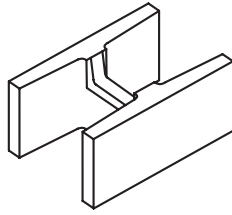

12x8x16
Double Open End Bond Beam
SPECIAL ORDER ONLY

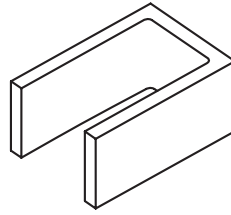

12x8x16
U-Lintel

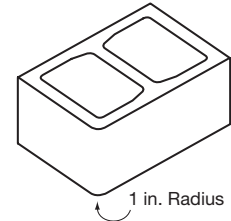

12x8x16
Standard Single Bullnose
SPECIAL ORDER ONLY

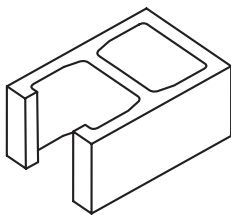

12x8x16
Open End Standard

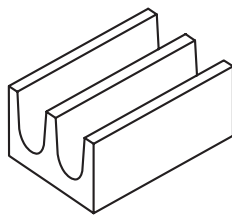

12x8x16
Solid Bottom W-Lintel

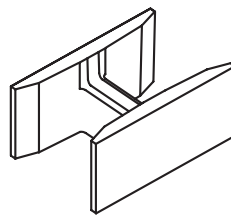

12x8x16
Speed Block

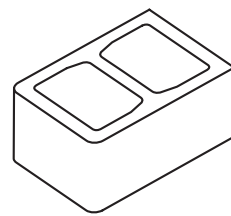

12x8x16
Standard Double Bullnose
SPECIAL ORDER ONLY

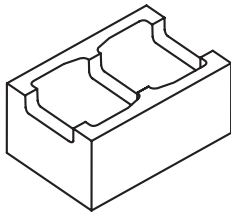

12x8x16
Bond Beam

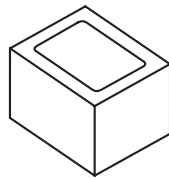

12x8x8
Half

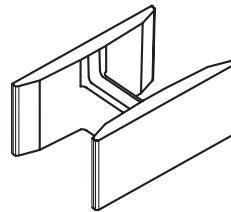

12x8x16
Grout Lock
SPECIAL ORDER ONLY

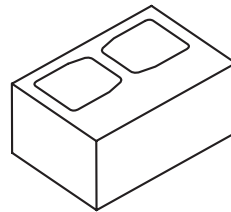

12x8x16
w/ 8-Inch Offset Core
SPECIAL ORDER ONLY

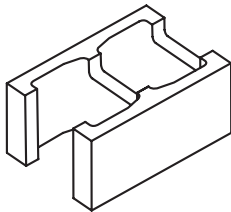

12x8x16
Open End Bond Beam

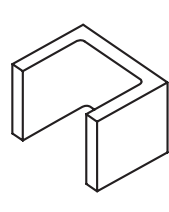

12x8x8
U-Lintel

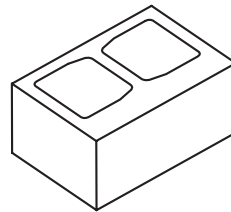

12x8x16
w/ 10-Inch Offset Core
SPECIAL ORDER ONLY

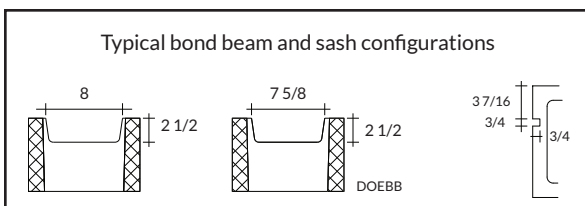

Offset Core units may be available in additional configurations.

Note: Open Ends and Bond Beam configurations as shown are representational; available profiles may differ.

16 Wide & Pilasters

16 Wide

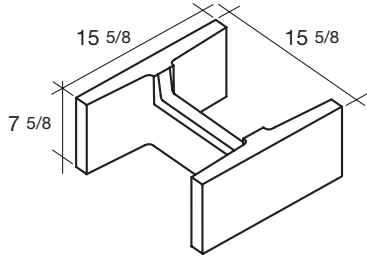

16x8x16
Double Open End Bond Beam
SPECIAL ORDER ONLY

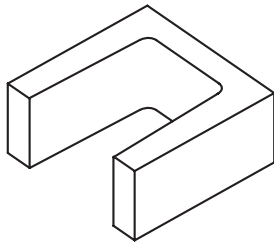

16x8x16
U-Lintel
SPECIAL ORDER ONLY

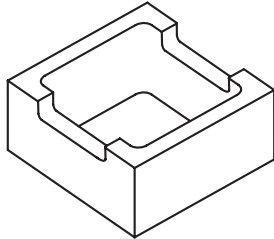

16x8x16
Ring Bond Beam
SPECIAL ORDER ONLY

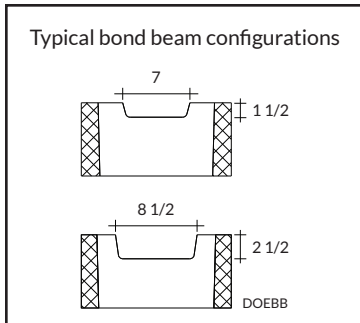

Columns/Pilasters

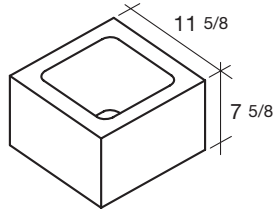

12x8x12
Ring

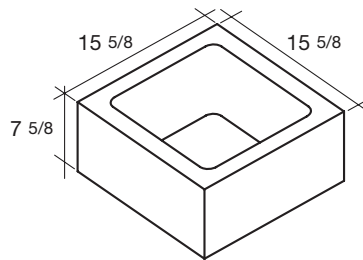

16x8x16
Ring

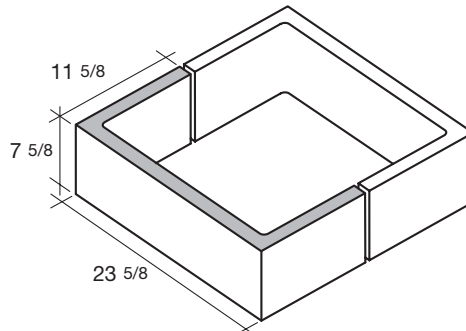

24x8x12
C-Alternate
SPECIAL ORDER ONLY

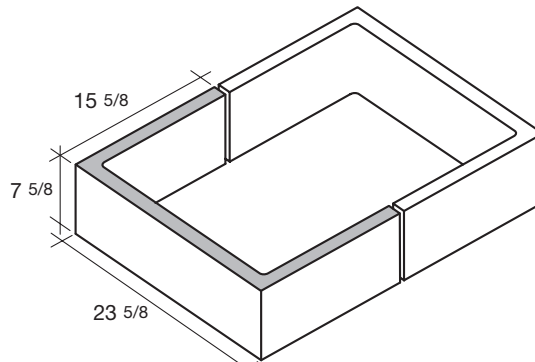

24x8x16
C-Alternate
SPECIAL ORDER ONLY

In-Wall Pilasters

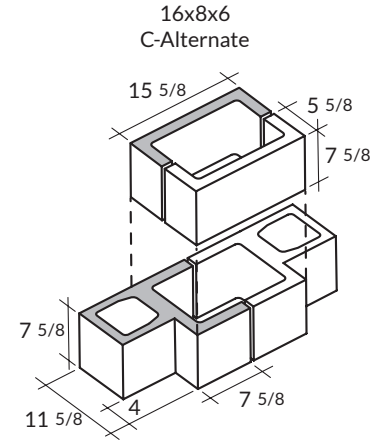

12x8x16
Banjo Pilaster

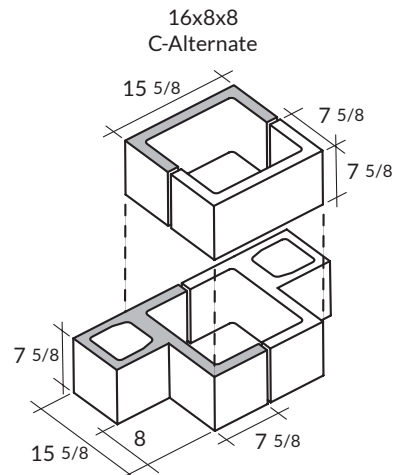

16x8x16
Banjo Pilaster

45-Degree, Y-Block, & Miter

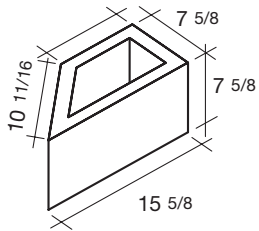

8x8x16
Standard 45-Degree
SPECIAL ORDER ONLY

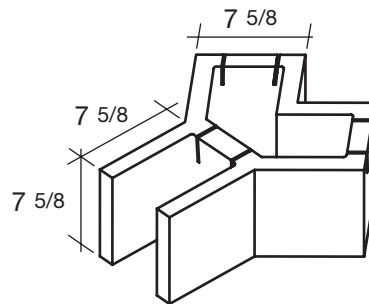

8x8x16
Y-Block Open End w/ KOBB
Also available in 6-inch wide.
SPECIAL ORDER ONLY

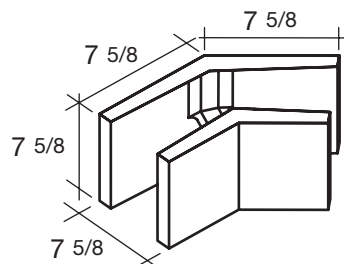
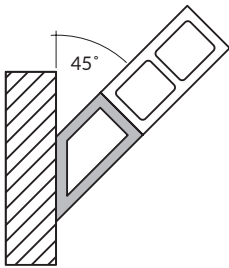
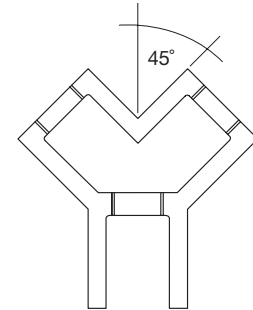

8x8x16
45-Degree Chevron DOE BB
Also available in 6-inch wide.
SPECIAL ORDER ONLY

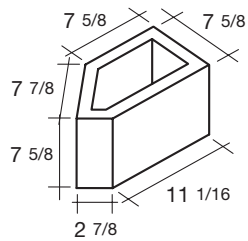
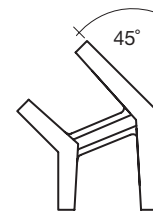

8x8x16
Corner 45-Degree
SPECIAL ORDER ONLY

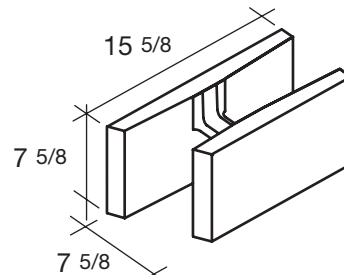

8x8x16
22.5-Degree Miter DOE BB
Left and Right
Also available in 6-inch wide.
SPECIAL ORDER ONLY

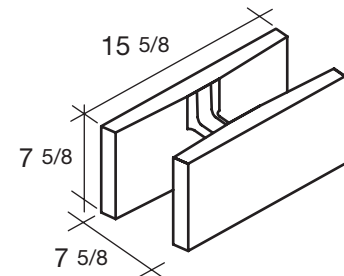
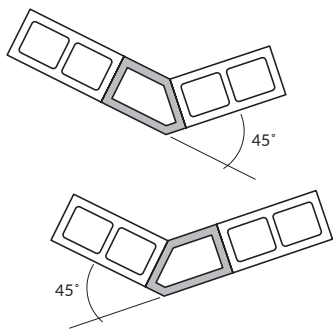
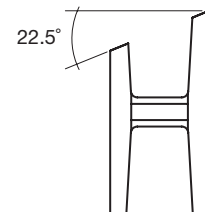

8x8x16
11.5-Degree Miter DOE BB
Left and Right
Also available in 6-inch wide.
SPECIAL ORDER ONLY

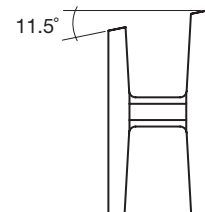

Miter Layouts

Example layouts of
Y-Block
45-Degree Chevron
22.5-Degree Miter
Double Open End Bond Beam

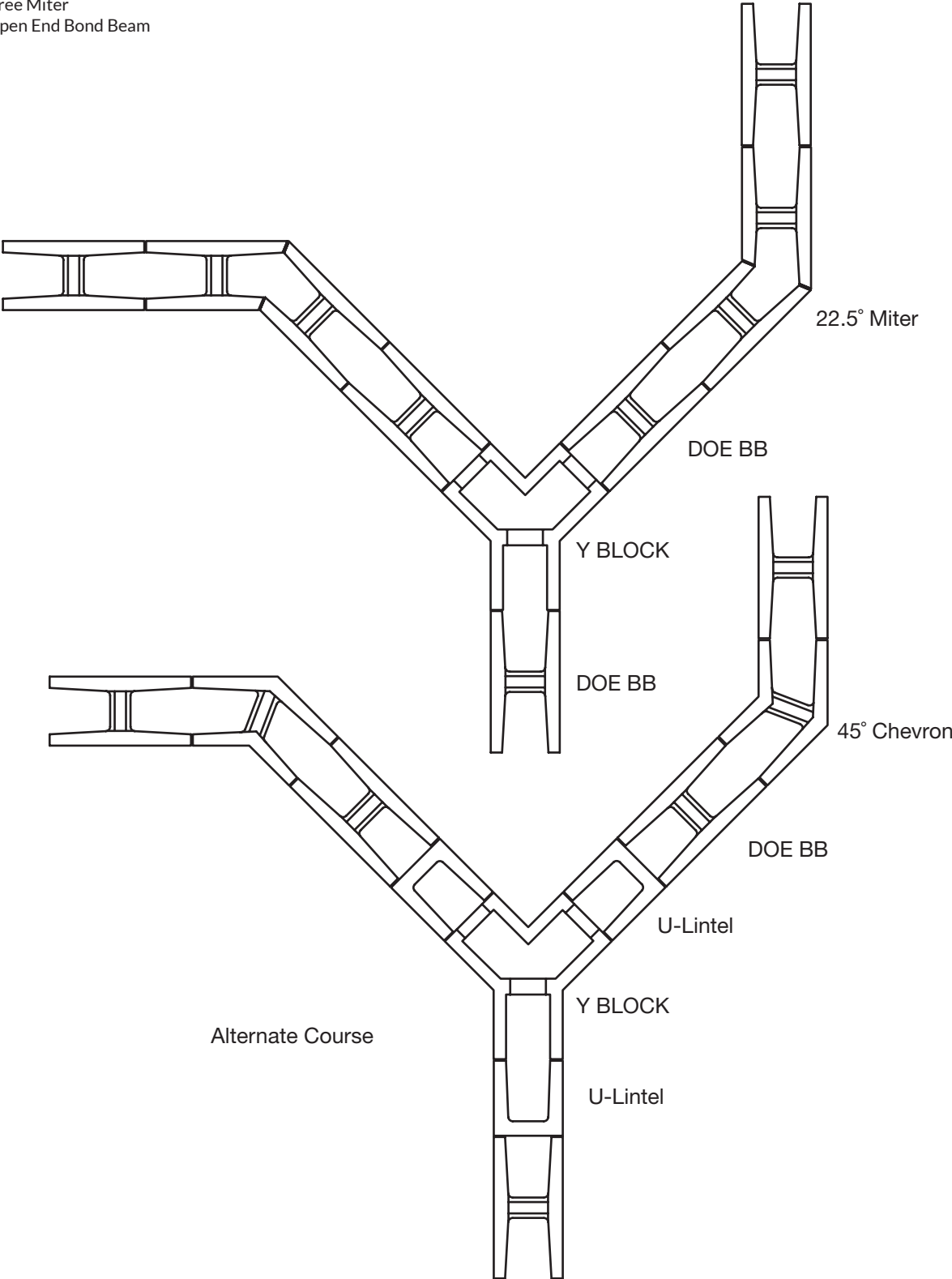

Radius

All radius dimensions are to the outside face.

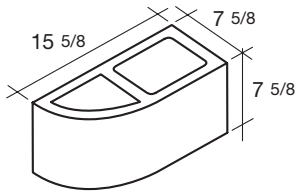

8x8x16
8-Inch Radius
SPECIAL ORDER ONLY



Radius ends cut from 8x8x16 unit.

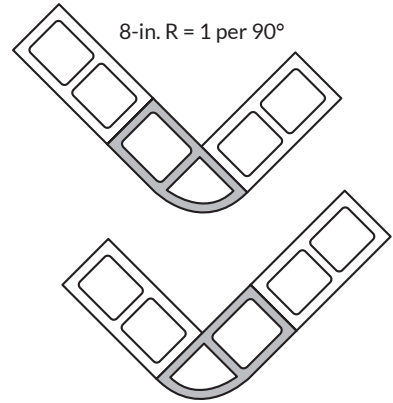

Alternate Course

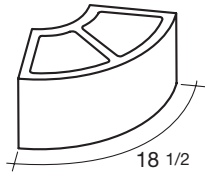

8x8x16
1-Foot Radius
SPECIAL ORDER ONLY

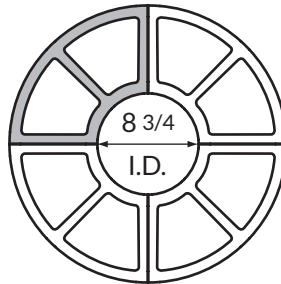

Ends of 1-Foot Radius are knock-out bond beams.
I.D.

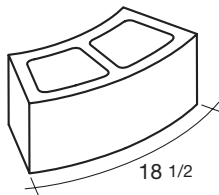

8x8x16
2-Foot Radius
SPECIAL ORDER ONLY

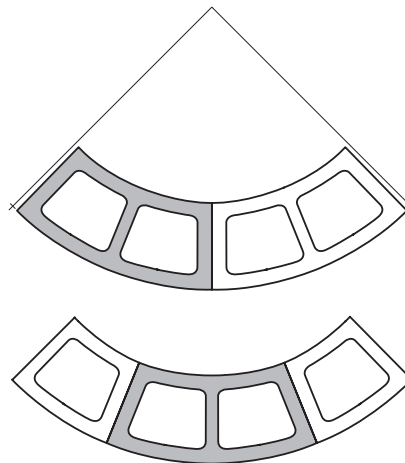

2-ft. R = 2 per 90°

Alternate Course

All radius dimensions are to the outside face.

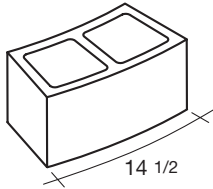

8x8x16
4-Foot Radius
SPECIAL ORDER ONLY

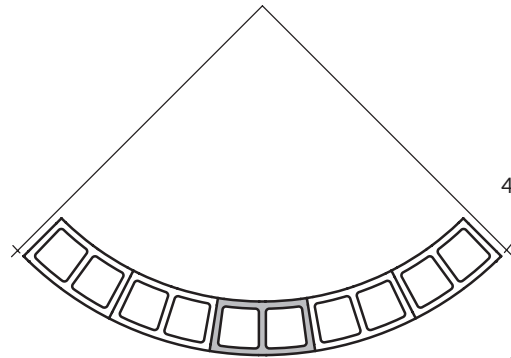

4-ft. R = 5 per 90°

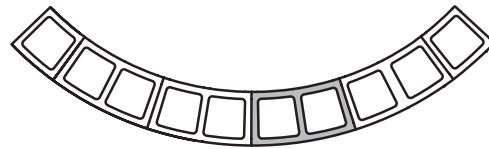

Alternate Course

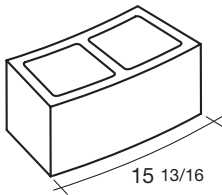

8x8x16
5-Foot 2-Inch Radius
SPECIAL ORDER ONLY

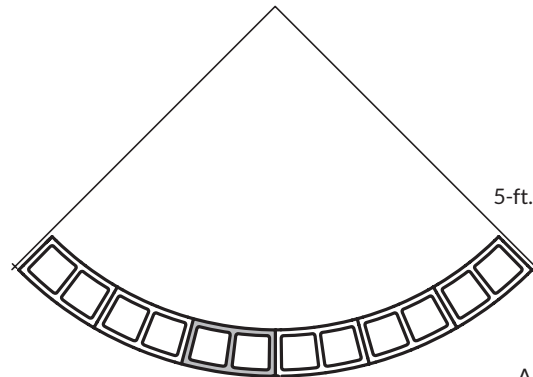

5-ft. 2-in. R = 6 per 90°

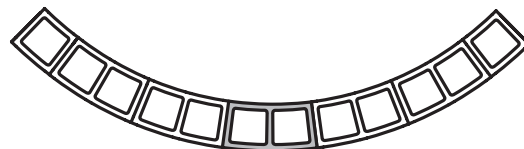

Alternate Course

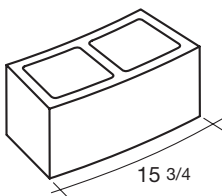

8x8x16
6-Foot Radius
SPECIAL ORDER ONLY

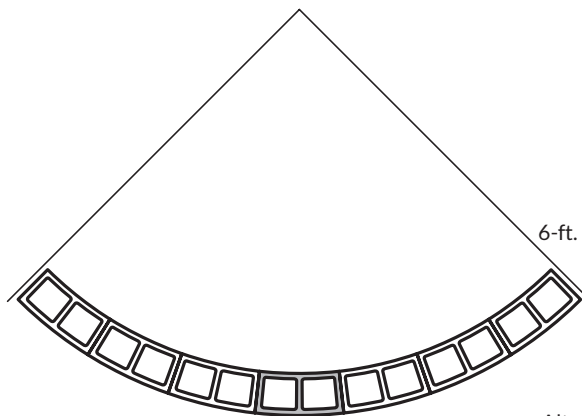

6-ft. R = 7 per 90°



Alternate Course

Caps

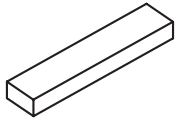

4x2x16
Cap

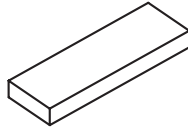

6x2x16
Cap

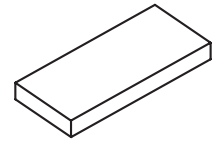

8x2x16
Cap

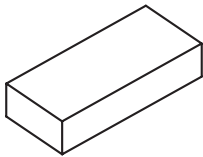

8x4x16
Solid Cap
SPECIAL ORDER ONLY

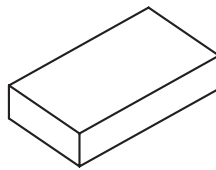

10x4x16
Solid Cap
SPECIAL ORDER ONLY

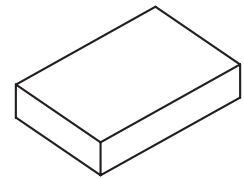

12x4x16
Solid Cap
SPECIAL ORDER ONLY

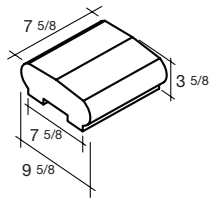

10x4x16
Mushroom Cap
LIMITED INVENTORY

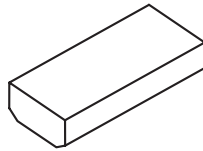

8x4x16
Beveled Cap
SPECIAL ORDER ONLY

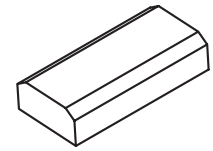

Beveled Cap
Alternate Orientation

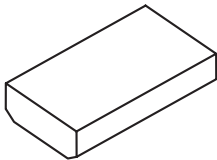

10x4x16
Beveled Cap
SPECIAL ORDER ONLY

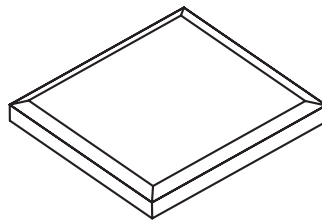

19.5x4x19.5
Beveled Pilaster Cap
SPECIAL ORDER ONLY

Screen Units



4x12x12
View-Lite I

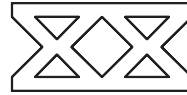
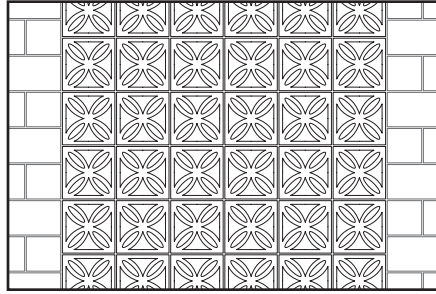

4x8x16
Vista

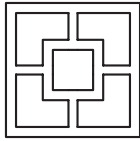
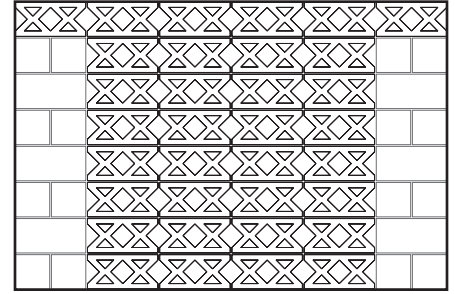

4x12x12
View-Lite IV

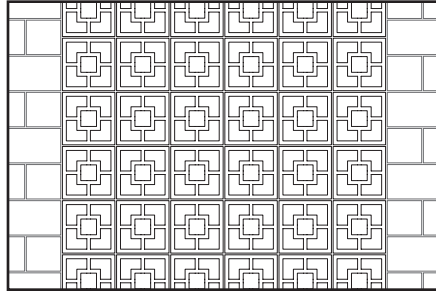

4x8x16 or 6x8x16
Grille-Lite 3

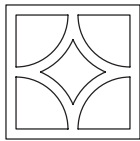
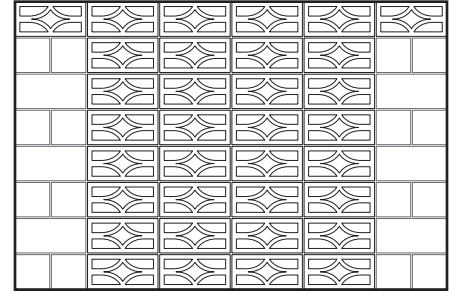

4x12x12
Empress

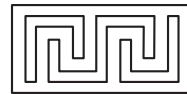
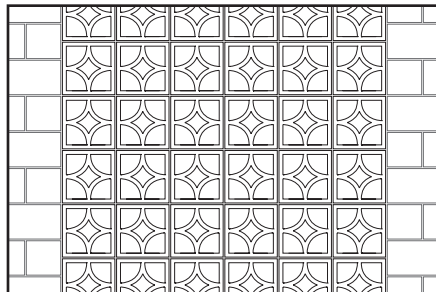

4x8x16
Pompeian

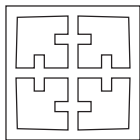
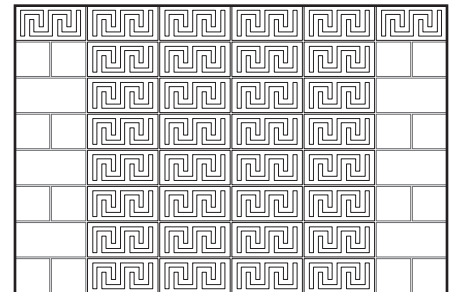

4x12x12
Maltese

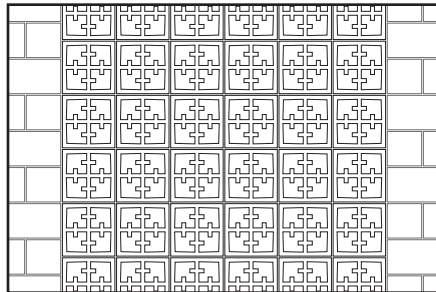

4x8x16 or 6x8x16
Grille-Lite 6

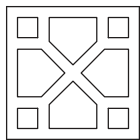
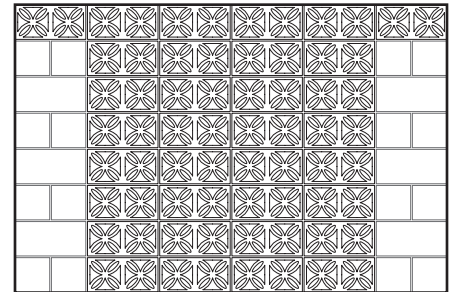

4x12x12
Venetian

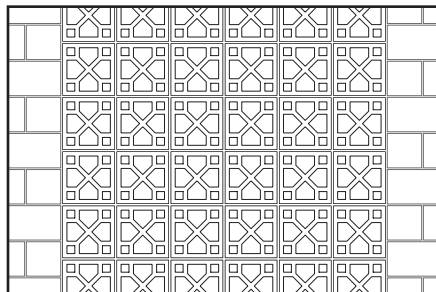

Screen Units may be limited in inventory and/or plant locations; please verify availability with your representative

Sill Block & Combed Face

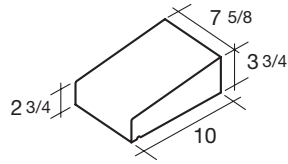

10x4x8
Sloped Sill Block

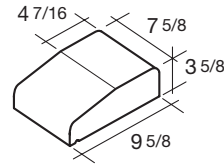

10x4x8
Flat Top Sill Block

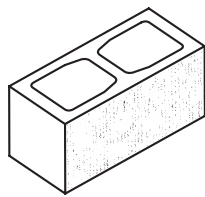

8x8x16
Combed Face
SPECIAL ORDER ONLY

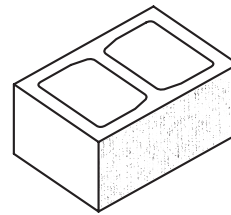

12x8x16
Combed Face
SPECIAL ORDER ONLY