

Split Face Concrete Masonry Units

4-Inch Wide	2
6-Inch Wide	3
8-Inch Wide	4
10-Inch Wide.....	6
12-Inch Wide.....	8
Pilasters	10
Radius.....	11
Caps	12

For current product information and the full range of available units and configurations, please visit www.AngelusBlock.com



4 Wide

4 High

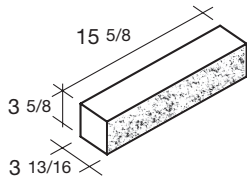

4x4x16
Solid Split 1-Side
SPECIAL ORDER ONLY

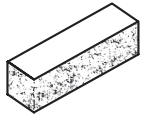

4x4x12
Solid Split 1-Side 1-End
SPECIAL ORDER ONLY

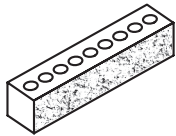

4x4x16
Solid Split 1-Side w/ Cores
SPECIAL ORDER ONLY

6 High

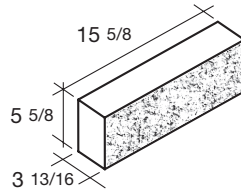

4x6x16
Solid Split 1-Side
SPECIAL ORDER ONLY

8 High

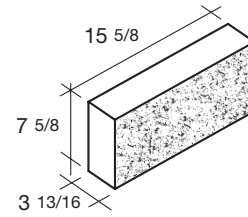

4x8x16
Solid Split 1-Side
SPECIAL ORDER ONLY

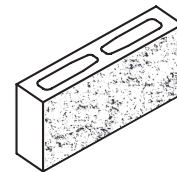

4x8x16
Standard Split 1-Side
SPECIAL ORDER ONLY

NOTE RELATED TO SPLIT FACE TEXTURE IN ASTM C90:
Split face dimensions, for the face that is split, is not considered in Permissible Variations of ASTM C90, as split faces inherently vary. Only precision, non-split faces are held to the tolerances.

4 High

8 High

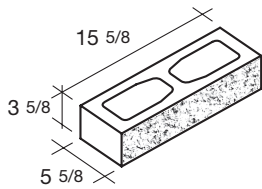

6x4x16
Standard Split 1-Side
SPECIAL ORDER ONLY

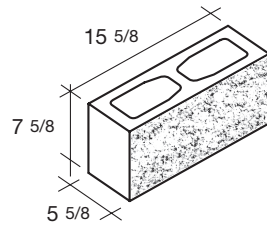

6x8x16
Standard Split 1-Side

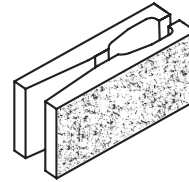

6x8x16
Open End Bond Beam Split 1-Side
SPECIAL ORDER ONLY

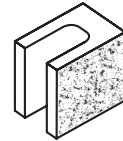

6x8x8
U-Intel Split 1-Side
SPECIAL ORDER ONLY

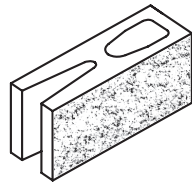

6x8x16
Open End Standard Split 1-Side
SPECIAL ORDER ONLY

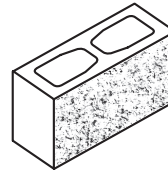

6x8x14
Corner Split 1-Side

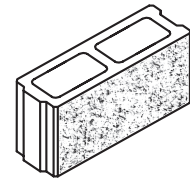

6x8x16
Tongue & Groove Beveled Ends
Split 1-Side

6 High

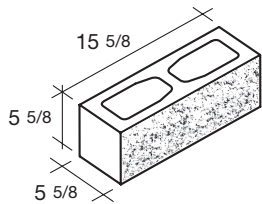

6x6x16
Standard Split 1-Side
SPECIAL ORDER ONLY

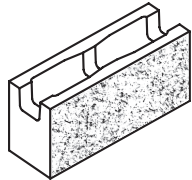

6x8x16
Bond Beam Split 1-Side

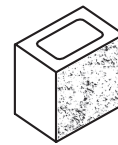

6x8x8
Half Split 1-Side

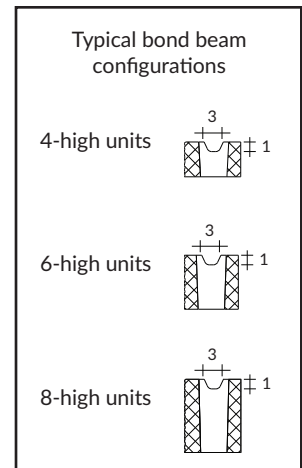

Other Split Configurations



Split 1-Side 1-End



Split 2-Sides



Split 2-Sides 1-End

Note: Open Ends and Bond Beam configurations as shown are representational; available profiles may differ.

NOTE RELATED TO SPLIT FACE TEXTURE IN ASTM C90:

Split face dimensions, for the face that is split, is not considered in Permissible Variations of ASTM C90, as split faces inherently vary. Only precision, non-split faces are held to the tolerances.

8 Wide

4 High

6 High

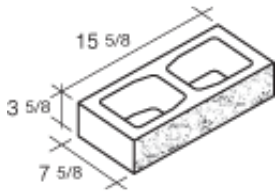

8x4x16
Standard Split 1-Side

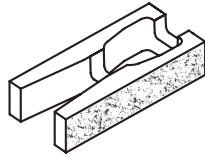

8x4x16
Open End Bond Beam Split 1-Side

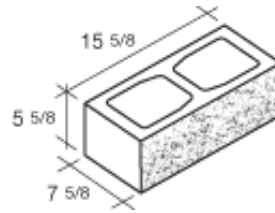

8x6x16
Standard Split 1-Side
SPECIAL ORDER ONLY

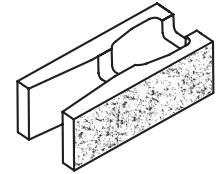

8x6x16
Open End Bond Beam Split 1-Side
SPECIAL ORDER ONLY

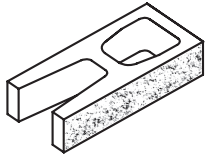

8x4x16
Open End Standard Split 1-Side

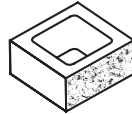

8x4x8
Half Split 1-Side

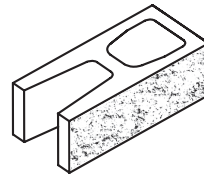

8x6x16
Open End Standard Split 1-Side
SPECIAL ORDER ONLY

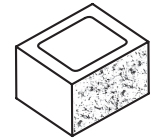

8x6x8
Half Split 1-Side
SPECIAL ORDER ONLY

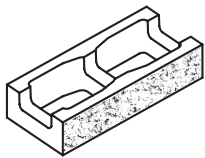

8x4x16
Bond Beam Split 1-Side

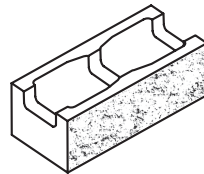

8x6x16
Bond Beam Split 1-Side
SPECIAL ORDER ONLY

Typical bond beam and sash configurations

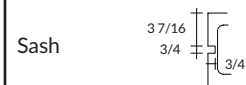
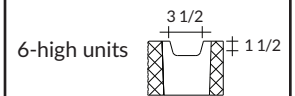

Other Split Configurations



Split 1-End Only

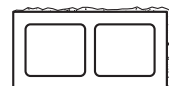

Split 1-Side 1-End

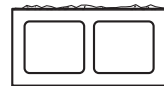

Split 2-Sides

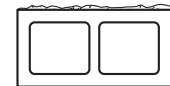

Split 2-Sides 1-End

Note: Open Ends and Bond Beam configurations as shown are representational; available profiles may differ.

NOTE RELATED TO SPLIT FACE TEXTURE IN ASTM C90:
Split face dimensions, for the face that is split, is not considered in Permissible Variations of ASTM C90, as split faces inherently vary. Only precision, non-split faces are held to the tolerances.

8 High

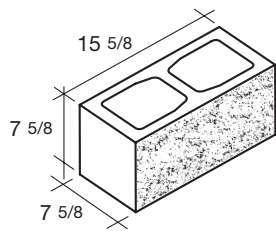

8x8x16
Standard Split 1-Side

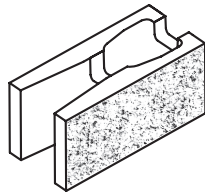

8x8x16
Open End Bond Beam Split 1-Side

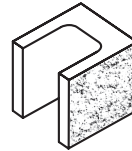

8x8x8
U-Lintel Split 1-Side

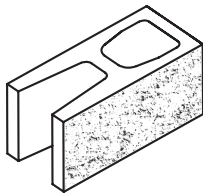

8x8x16
Open End Standard Split 1-Side

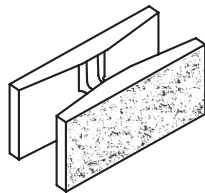

8x8x16
Double Open End Bond Beam Split 1-Side

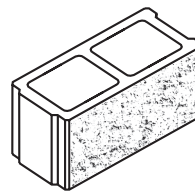

8x8x16
Tongue & Groove Beveled Ends Split 1-Side

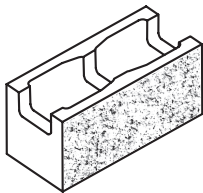

8x8x16
Bond Beam Split 1-Side

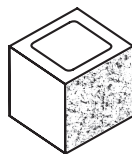

8x8x8
Half Split 1-Side

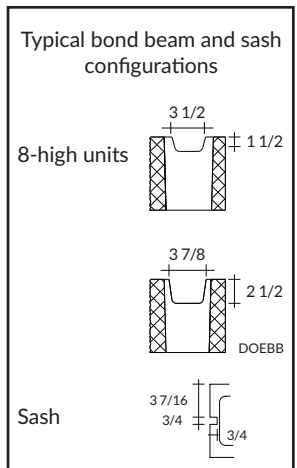

Other Split Configurations

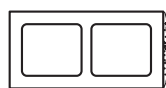

Split 1-End Only

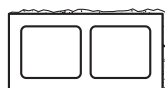

Split 1-Side 1-End

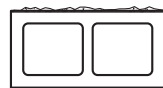

Split 2-Sides

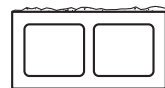

Split 2-Sides 1-End

Note: Open Ends and Bond Beam configurations as shown are representational; available profiles may differ.

NOTE RELATED TO SPLIT FACE TEXTURE IN ASTM C90:

Split face dimensions, for the face that is split, is not considered in Permissible Variations of ASTM C90, as split faces inherently vary. Only precision, non-split faces are held to the tolerances.

10 Wide

4 High

6 High

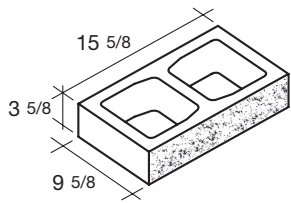

10x4x16
Standard Split 1-Side
SPECIAL ORDER ONLY

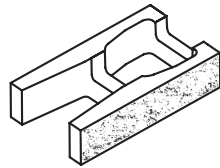

10x4x16
Open End Bond Beam Split 1-Side
SPECIAL ORDER ONLY

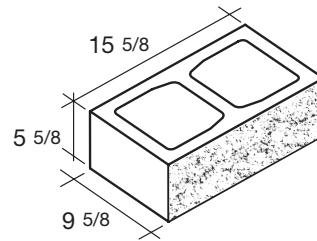

10x6x16
Standard Split 1-Side
SPECIAL ORDER ONLY

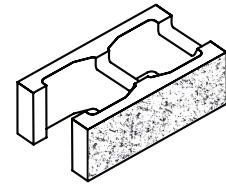

10x6x16
Open End Bond Beam Split 1-Side
SPECIAL ORDER ONLY

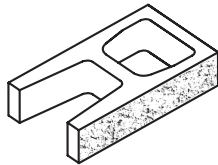

10x4x16
Open End Standard Split 1-Side
SPECIAL ORDER ONLY

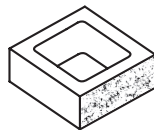

10x4x8
Half Split 1-Side
SPECIAL ORDER ONLY

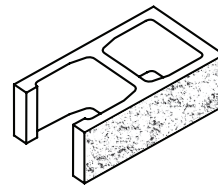

10x6x16
Open End Standard Split 1-Side
SPECIAL ORDER ONLY

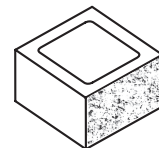

10x6x8
Half Split 1-Side
SPECIAL ORDER ONLY

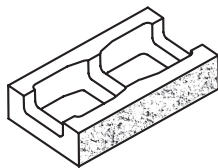

10x4x16
Bond Beam Split 1-Side
SPECIAL ORDER ONLY

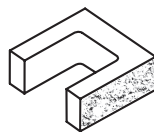

10x4x8
U-Lintel Split 1-Side
SPECIAL ORDER ONLY

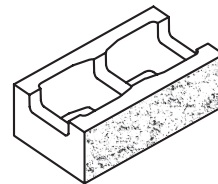

10x6x16
Bond Beam Split 1-Side
SPECIAL ORDER ONLY

Typical bond beam and sash configurations

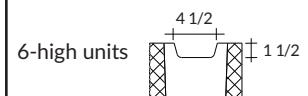

Other Split Configurations

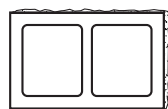

Split 1-Side 1-End

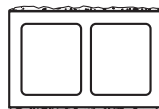

Split 2-Sides

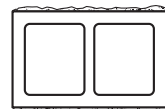

Split 2-Sides 1-End

Note: Open Ends and Bond Beam configurations as shown are representational; available profiles may differ.

NOTE RELATED TO SPLIT FACE TEXTURE IN ASTM C90:

Split face dimensions, for the face that is split, is not considered in Permissible Variations of ASTM C90, as split faces inherently vary. Only precision, non-split faces are held to the tolerances.

8 High

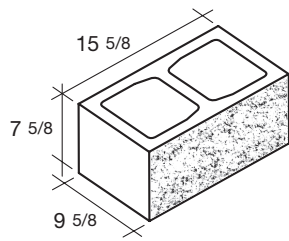

10x8x16
Standard Split 1-Side
SPECIAL ORDER ONLY

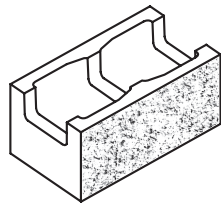

10x8x16
Bond Beam Split 1-Side
SPECIAL ORDER ONLY

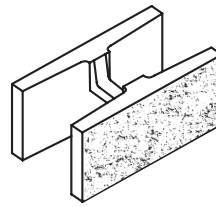

10x8x16
Double Open End Bond Beam
Split 1-Side
SPECIAL ORDER ONLY

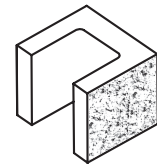

10x8x8
U-Intel Split 1-Side
SPECIAL ORDER ONLY

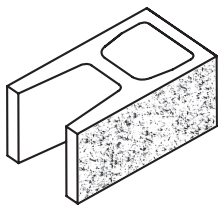

10x8x16
Open End Standard Split 1-Side
SPECIAL ORDER ONLY

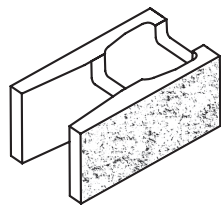

10x8x16
Open End Bond Beam
Split 1-Side
SPECIAL ORDER ONLY

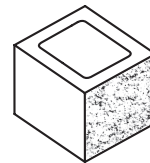

10x8x8
Half Split 1-Side
SPECIAL ORDER ONLY

Typical bond beam and sash configurations

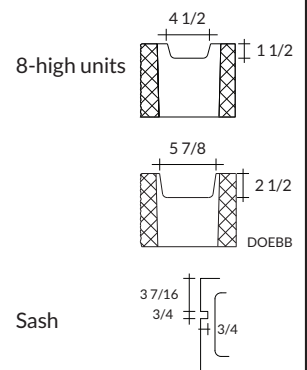

Other Split Configurations

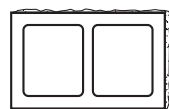

Split 1-Side 1-End

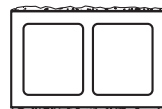

Split 2-Sides

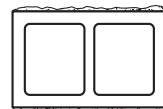

Split 2-Sides 1-End

Note: Open Ends and Bond Beam configurations as shown are representational; available profiles may differ.

NOTE RELATED TO SPLIT FACE TEXTURE IN ASTM C90:

Split face dimensions, for the face that is split, is not considered in Permissible Variations of ASTM C90, as split faces inherently vary. Only precision, non-split faces are held to the tolerances.

12 Wide

4 High

6 High

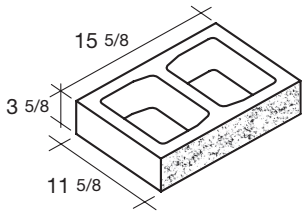

12x4x16
Standard Split 1-Side
SPECIAL ORDER ONLY

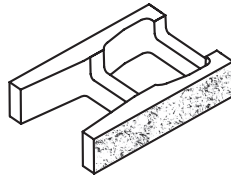

12x4x16 Split 1-Side
Open End Bond Beam
SPECIAL ORDER ONLY

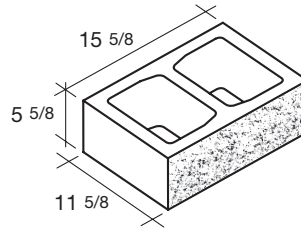

12x6x16 Split 1-Side
Standard
SPECIAL ORDER ONLY

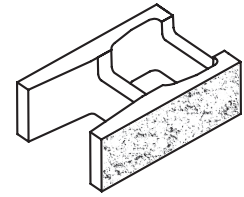

12x6x16 Split 1-Side
Open End Bond Beam
SPECIAL ORDER ONLY

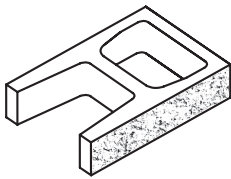

12x4x16
Open End Standard Split 1-Side
SPECIAL ORDER ONLY

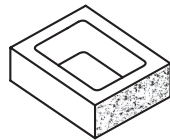

12x4x8 Split 1-Side
Half
SPECIAL ORDER ONLY

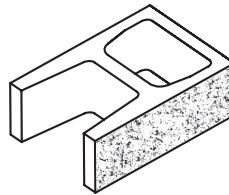

12x6x16 Split 1-Side
Open End Standard
SPECIAL ORDER ONLY

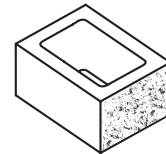

12x6x8 Split 1-Side
Half
SPECIAL ORDER ONLY

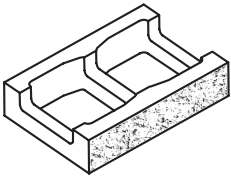

12x4x16
Bond Beam Split 1-Side
SPECIAL ORDER ONLY

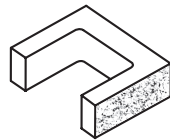

12x4x8 Split 1-Side
U-Lintel
SPECIAL ORDER ONLY

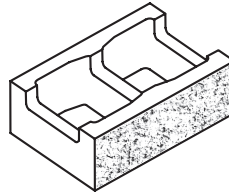

12x6x16 Split 1-Side
Bond Beam
SPECIAL ORDER ONLY

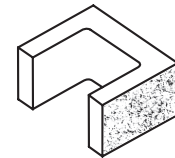

12x6x8 Split 1-Side
U-Lintel
SPECIAL ORDER ONLY

Note: Open Ends and Bond Beam configurations as shown are representational; available profiles may differ.

Other Split Configurations

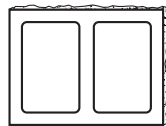

Split 1-Side 1-End

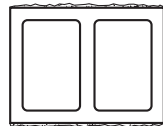

Split 2-Sides

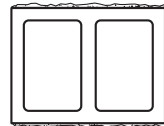

Split 2-Sides 1-End

Typical bond beam and sash configurations

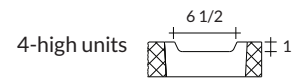

4-high units

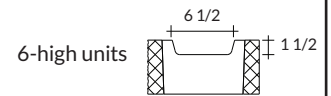

6-high units

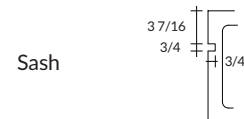

Sash

NOTE RELATED TO SPLIT FACE TEXTURE IN ASTM C90:

Split face dimensions, for the face that is split, is not considered in Permissible Variations of ASTM C90, as split faces inherently vary. Only precision, non-split faces are held to the tolerances.

8 High

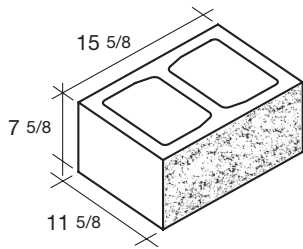

12x8x16
Standard Split 1-Side

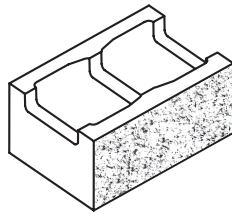

12x8x16
Bond Beam Split 1-Side

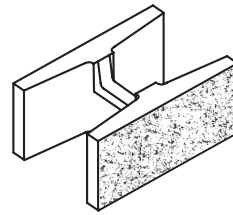

12x8x16
Double Open End Bond Beam
Split 1-Side
SPECIAL ORDER ONLY

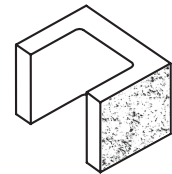

12x8x16
U-Lintel Split 1-Side

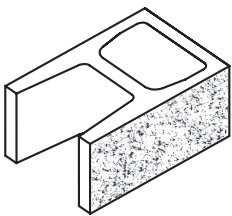

12x8x16
Open End Standard Split 1-Side

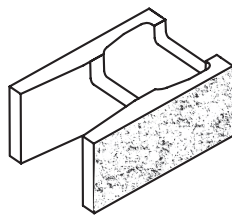

12x8x16
Open End Bond Beam
Split 1-Side

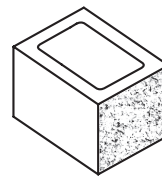

12x8x16
Half Split 1-Side

Note: Open Ends and Bond Beam configurations as shown are representational; available profiles may differ.

Other Split Configurations

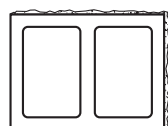

Split 1-Side 1-End

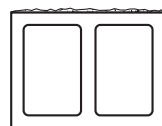

Split 2-Sides

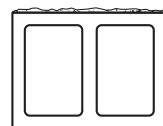

Split 2-Sides 1-End

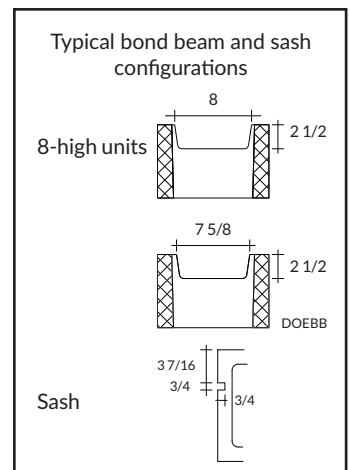

NOTE RELATED TO SPLIT FACE TEXTURE IN ASTM C90:

Split face dimensions, for the face that is split, is not considered in Permissible Variations of ASTM C90, as split faces inherently vary. Only precision, non-split faces are held to the tolerances.

Pilasters

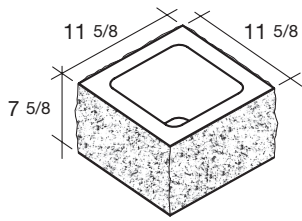

12x8x12
Ring Split 4-Sides

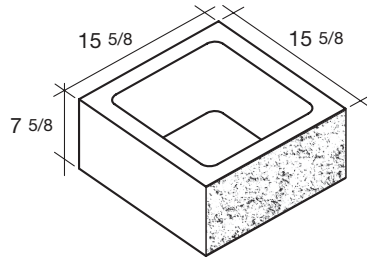

16x8x16
Ring Split 1-Side
LIMITED INVENTORY

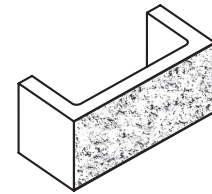

16x8x8
C-Alternate Split 1-Side
SPECIAL ORDER ONLY

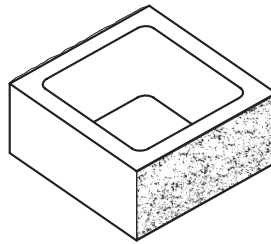

16x8x16
Ring Split 2-Sides
SPECIAL ORDER ONLY

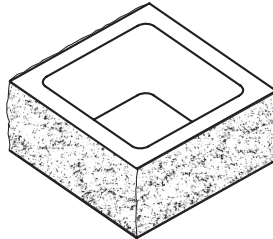

16x8x16
Ring Split 2-Sides 1-End
SPECIAL ORDER ONLY

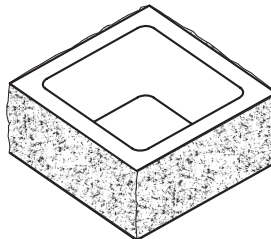

16x8x16
Ring Split 4-Sides
Manufactured at Orange Plant only

NOTE RELATED TO SPLIT FACE TEXTURE IN ASTM C90:

Split face dimensions, for the face that is split, is not considered in Permissible Variations of ASTM C90, as split faces inherently vary. Only precision, non-split faces are held to the tolerances.

Radius

All radius dimensions are to the outside face.

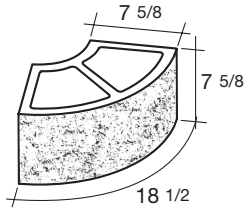

8x8x16
1-Foot Radius Split 1-Side
SPECIAL ORDER ONLY

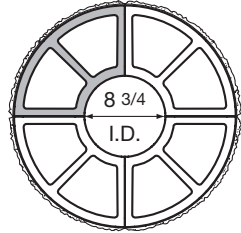

Ends of 1-Foot Radius are
knock-out bond beams.

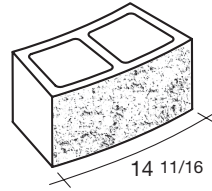

8x8x16
4-Foot Radius Split 1-Side
SPECIAL ORDER ONLY

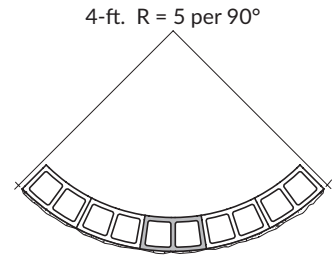

Alternate Course

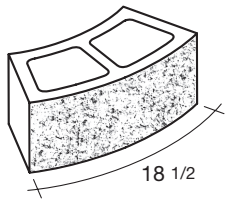

8x8x16
2-Foot Radius Split 1-Side
SPECIAL ORDER ONLY

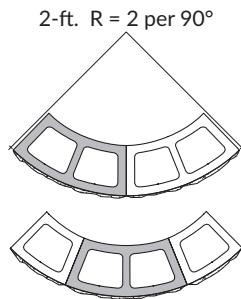

Alternate Course

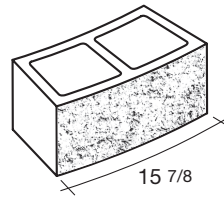

8x8x16
5-Foot 2-Inch Radius Split 1-Side
SPECIAL ORDER ONLY

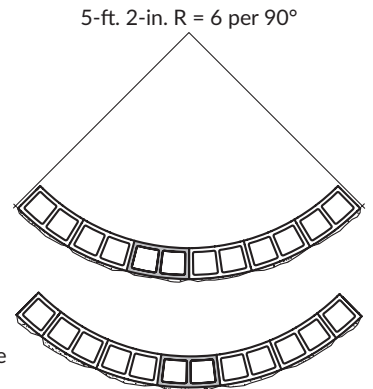

Alternate Course

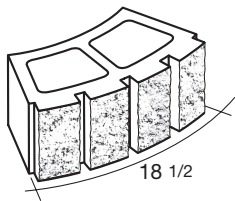

8x8x16
2-Foot Radius 4-Score Split 1-Side
SPECIAL ORDER ONLY

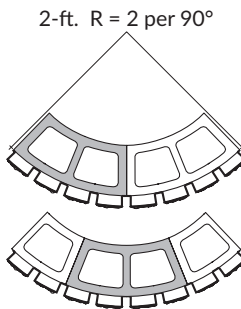

Alternate Course

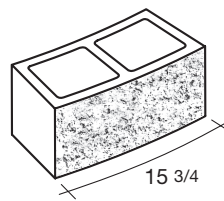

8x8x16
6-Foot Radius Split 1-Side
SPECIAL ORDER ONLY

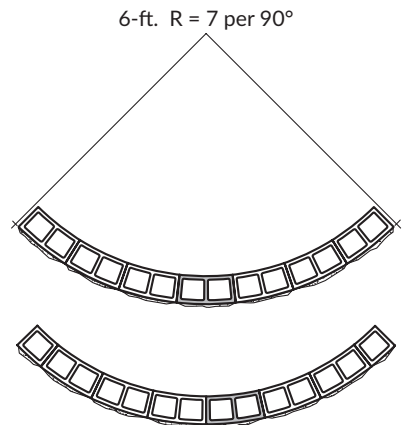

Alternate Course

NOTE RELATED TO SPLIT FACE TEXTURE IN ASTM C90:

Split face dimensions, for the face that is split, is not considered in Permissible Variations of ASTM C90, as split faces inherently vary. Only precision, non-split faces are held to the tolerances.

Caps

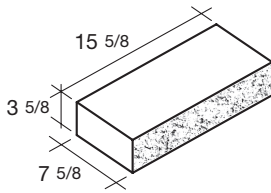

8x4x16
Solid Split 1-Side
SPECIAL ORDER ONLY



8x4x16
Solid Split 2-Sides
SPECIAL ORDER ONLY

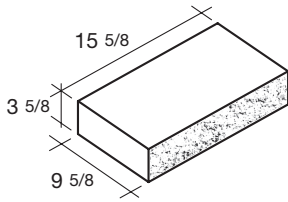

10x4x16
Solid Split 1-Side
SPECIAL ORDER ONLY



10x4x16
Solid Split 2-Sides
SPECIAL ORDER ONLY

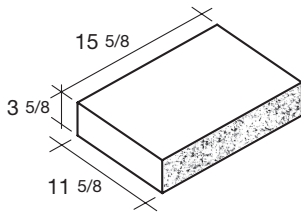

12x4x16
Solid Split 1-Side
SPECIAL ORDER ONLY



12x4x16
Solid Split 2-Sides
SPECIAL ORDER ONLY

NOTE RELATED TO SPLIT FACE TEXTURE IN ASTM C90:

Split face dimensions, for the face that is split, is not considered in Permissible Variations of ASTM C90, as split faces inherently vary. Only precision, non-split faces are held to the tolerances.



www.AngelusBlock.com info@AngelusBlock.com

©2024 Angelus Block Co., Inc.

The information herein is true and correct to the best of our knowledge but is subject to amendment or correction at any time, without notice. Angelus Block Co., Inc. does not assume responsibility or liability, including liability for negligence, for errors or omissions in this information or in its use in the preparations of architectural or engineering plans or specifications.